

TAKE4™ TAKE8™ DOUBLETAKE™

SET-UP INSTRUCTIONS

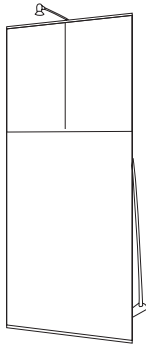

How to set up your literature holder:

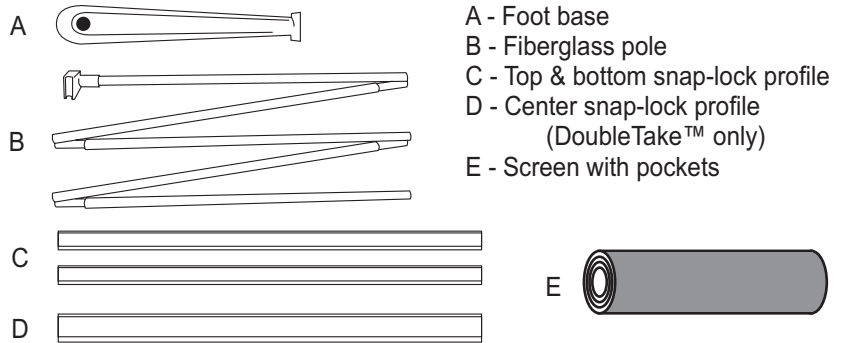

Note: Always roll graphic "image side out" during storage.

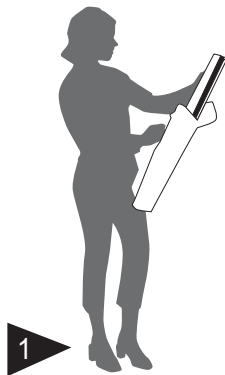

Carefully remove Take™ product from bag.



Slide metal foot base onto bottom profile of the graphic.

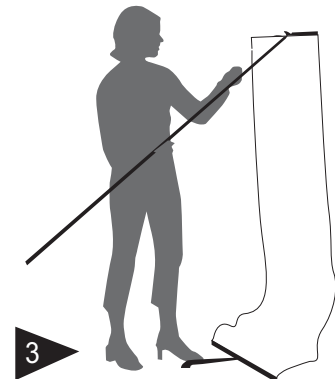

Assemble pole. Attach top pole connector to top profile of the graphic.

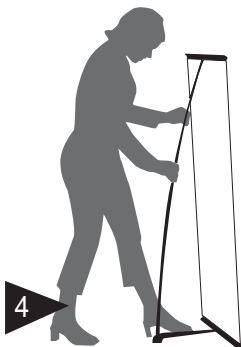

Flex pole and insert bottom of pole into the hole of metal foot base.

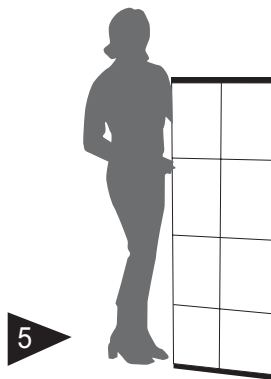

Display can be repositioned after set up.

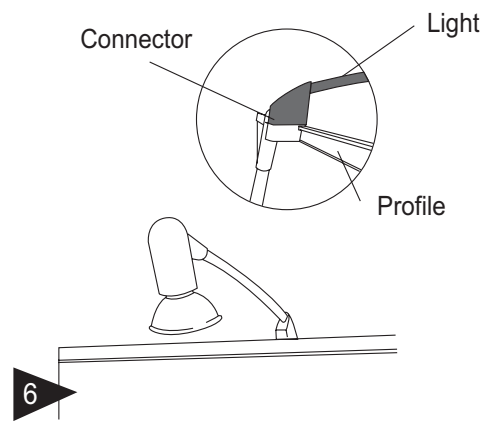

OPTIONAL
To attach light, place into top of pole connector.



1225 Alton Road, Port Charlotte, FL 33952 • Phone 941.979.9698 • FAX 407.209.3579

AAA DISPLAY GROUP
Portable, Modular, and Custom Display Systems